

ANEXO ÚNICO

**MANUAL DE MARCA
GOV/SC 2023**

I N D I C E

Estudo Revitalização Brasão	03
Marca	10
Marca Digital	20
Placas	26
Cartão Visitas	30
Marcas Secretarias	31
Aplicações Diversas	36

ESTUDO DE REVITALIZAÇÃO DO BRASÃO DE ARMAS

Brasão de Armas

Brasão de Armas, original como foi concebido em 1895 com a grafia "th" em "Catarina". Desenho rico em detalhes, com hachuras para dar volume.



Brasão estilizado "serigrafado" em 1953 para aplicação na atual bandeira do estado, perdendo todos os seus detalhes e volumes, pobre em traçado. A técnica utilizada para a estilização (não consta historicamente) acabou trazendo erros geométricos para o brasão.



Brasão de Armas - Erros na estilização

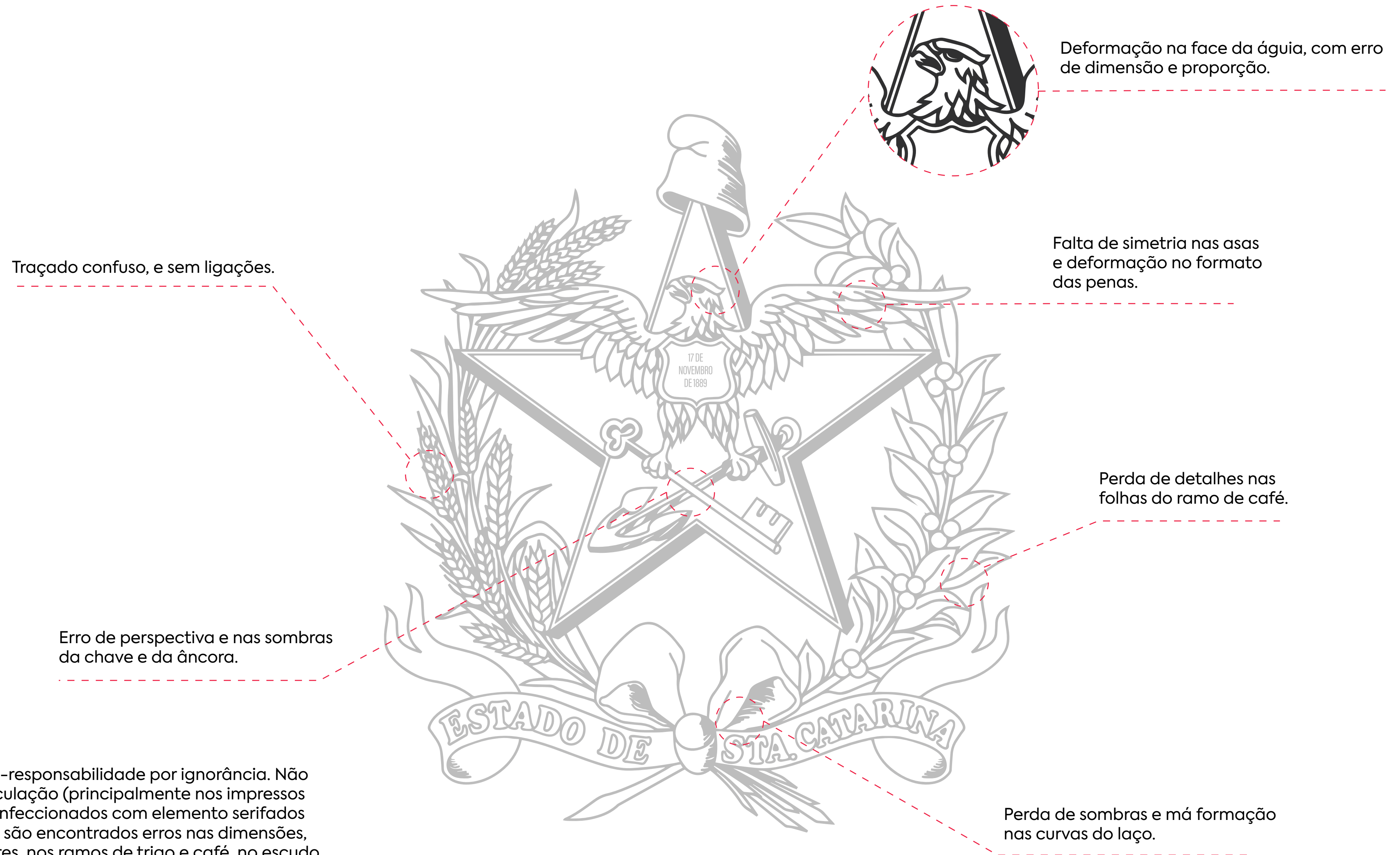

“É a concessão de auto-responsabilidade por ignorância. Não raro exemplares em circulação (principalmente nos impressos para escolares e nos confeccionados com elemento serifados para o uso em mastros) são encontrados erros nas dimensões, nas proporções, nas cores, nos ramos de trigo e café, no escudo, no barrete frígido e na estrela”

A Águia Da Tua Bandeira - Theobaldo Jamundá (1988)

Brasão de Armas - Correção de estilização



OUTLINE



Revitalização do brasão



Malha da bandeira

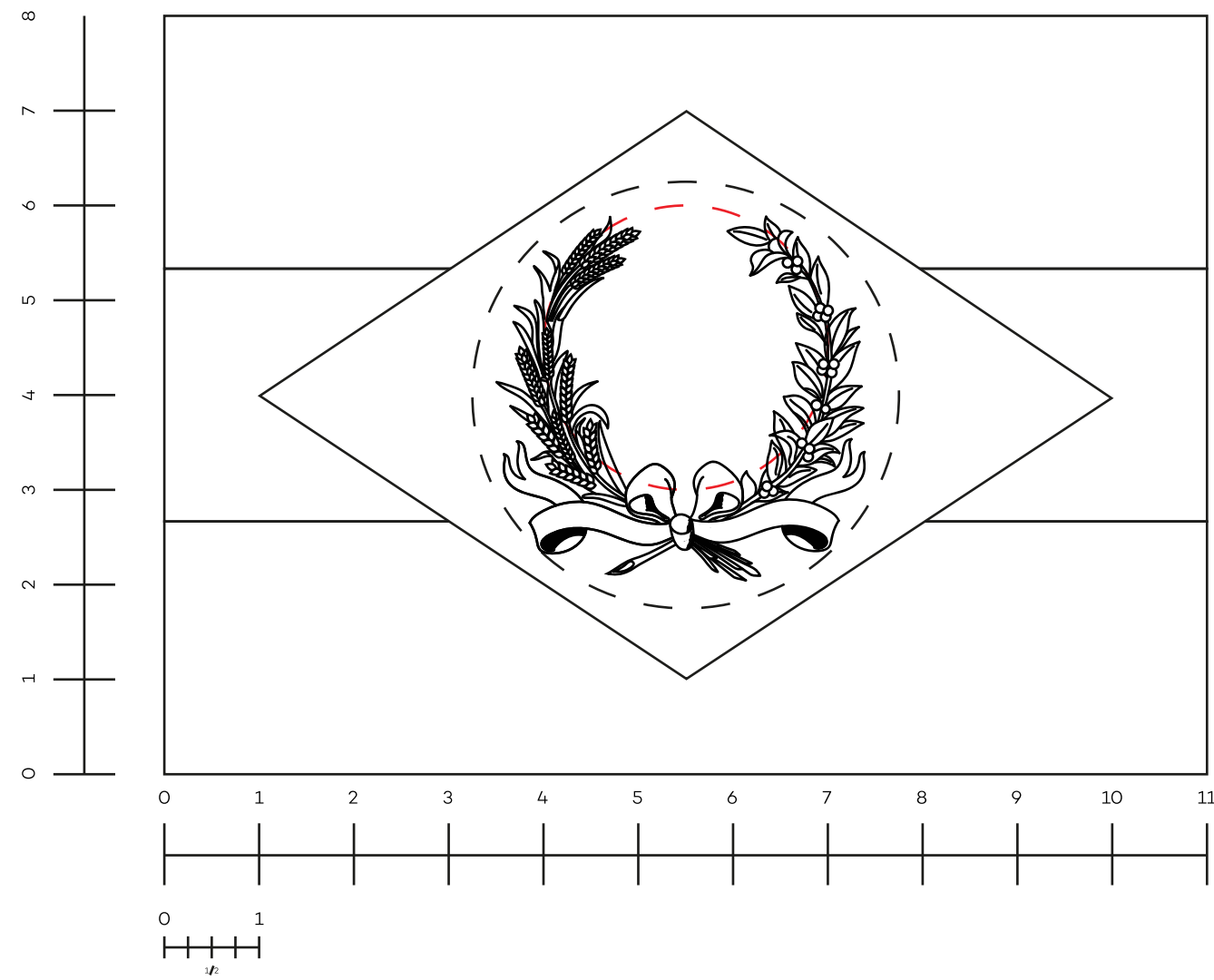
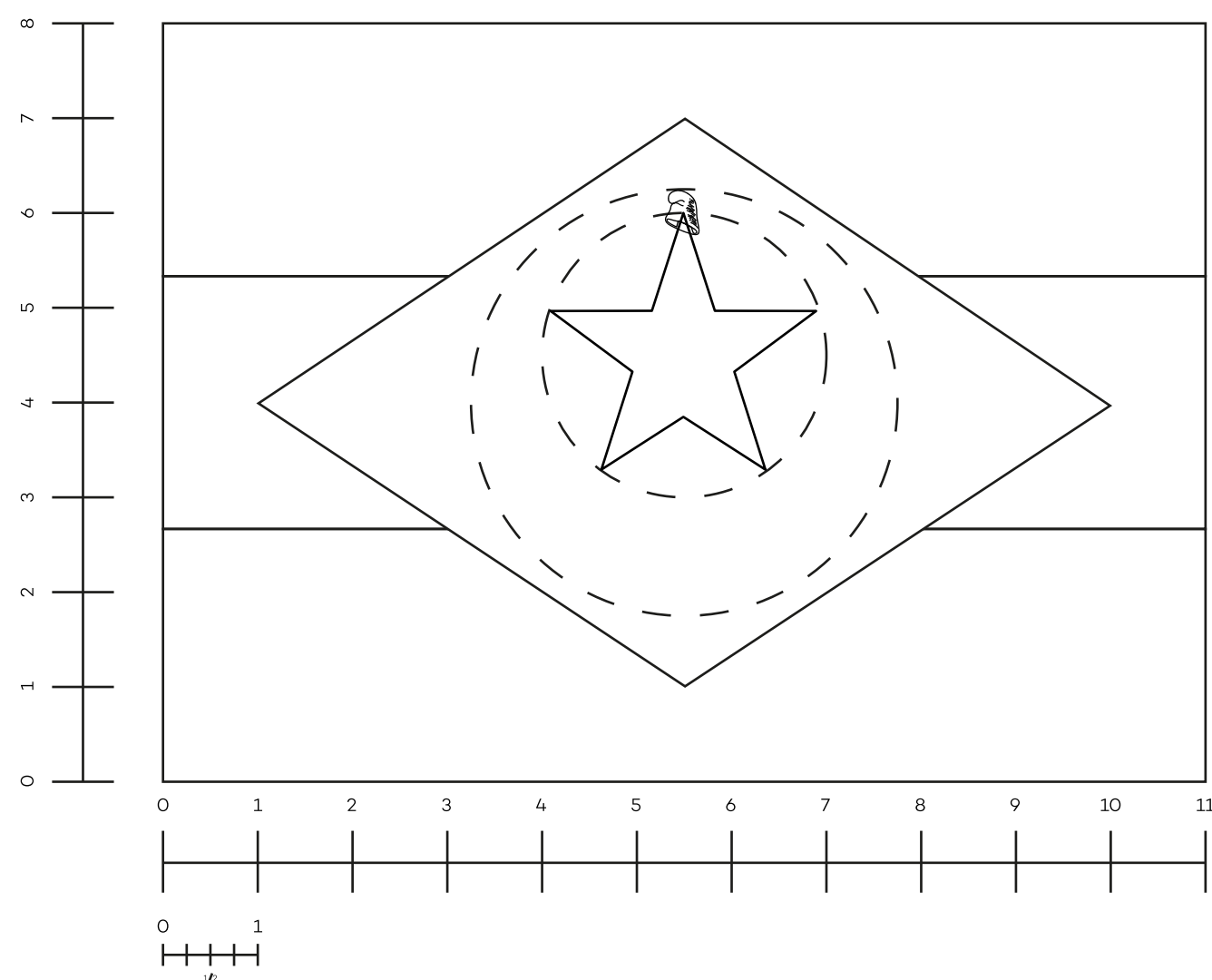
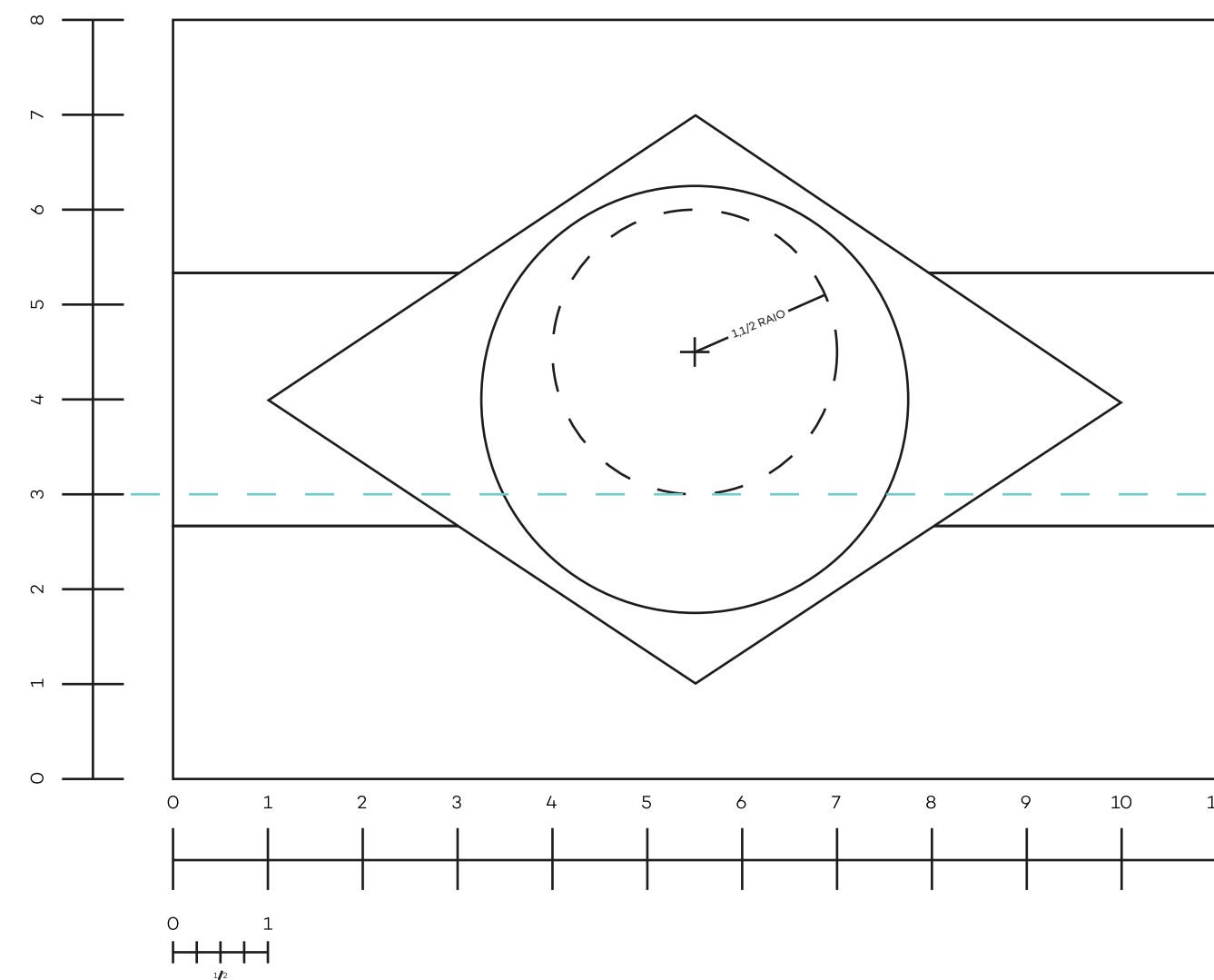
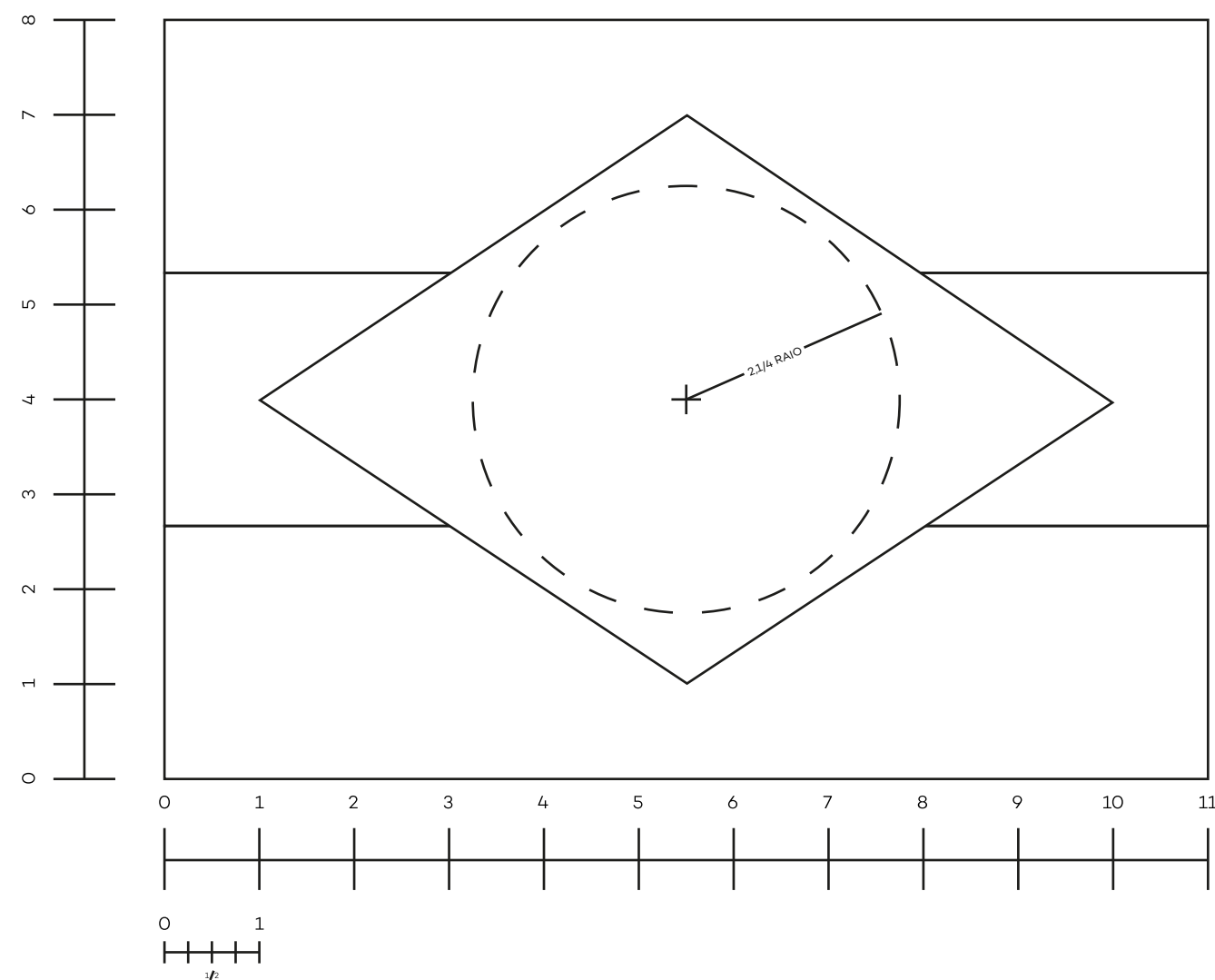
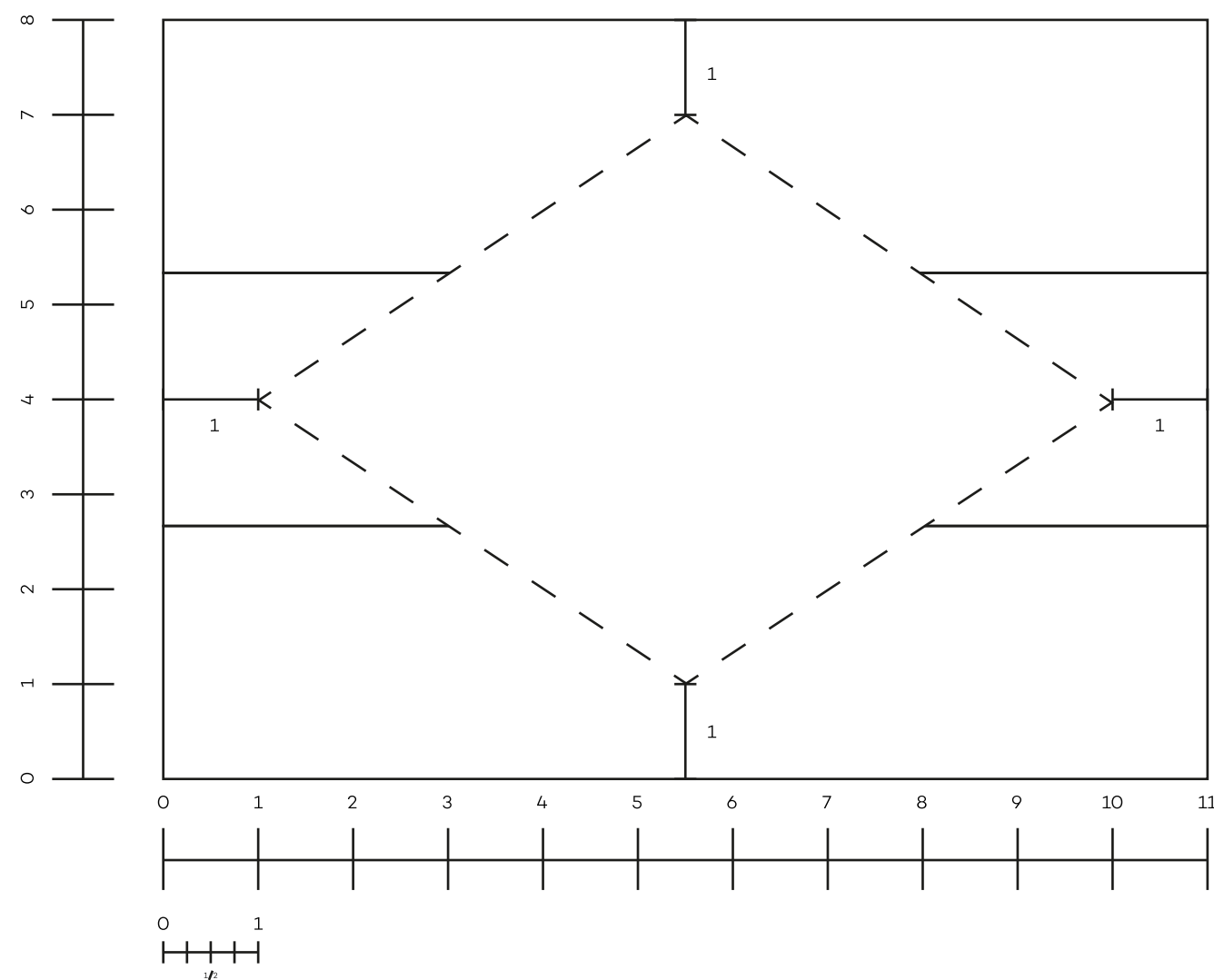

De acordo com o Decreto 605/1954, a bandeira do Estado de Santa Catarina é tripartida, com duas listras encarnadas e uma branca, alternadas, nas dimensões de 11 unidades de comprimento por 8 de largura. No centro dela dispõe um paralelogramo em verde claro, cujas pontas distam uma unidade de comprimento das bordas da bandeira. Dentro deste repousam as armas do estado, estando circunscritas em um círculo imaginário de 2,25 unidades de raio, de modo que o cruzamento da chave e da âncora se dê no centro da bandeira. O escudo das armas em forma de estrela se encontra inscrito num círculo, também imaginário, de 1,5 unidades, centrado a uma unidade de 0,375 acima do cruzamento da chave e da âncora.



Bandeira da República Juliana (1839)

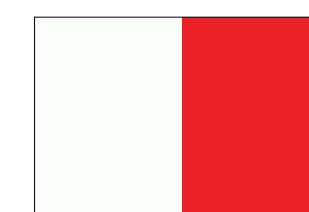

Bandeira da província de Santa Catarina (até 1891)

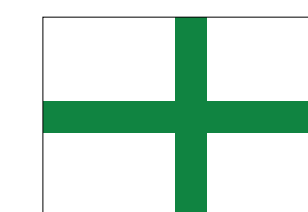

Bandeira dos catarinenses na Guerra do Contestado (1912-1915).

Bandeira com brasão revitalizado



A MARCA

Linha do tempo das marcas

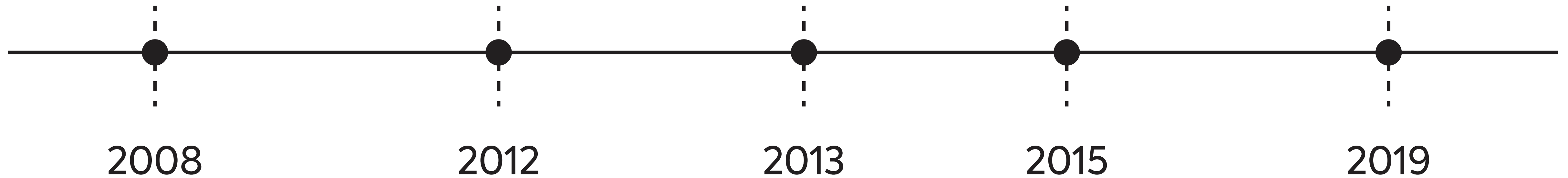



**GOVERNO DE
SANTA
CATARINA**

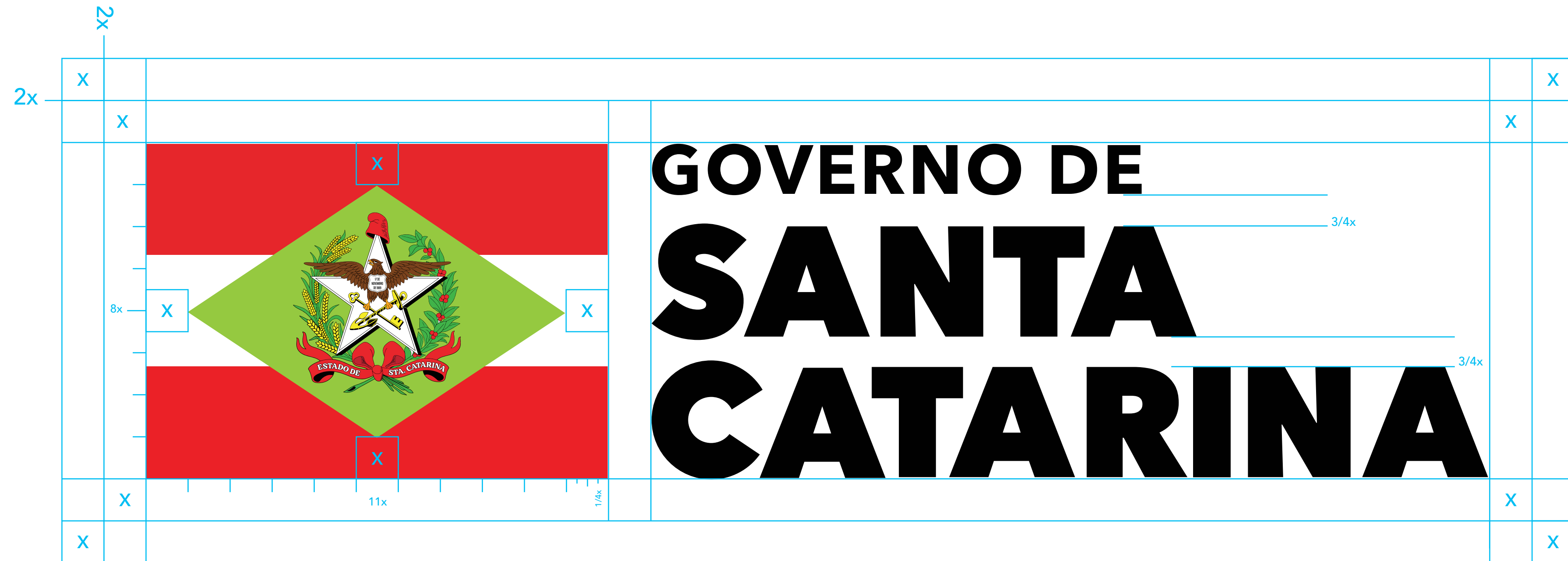

Aa

AVENIR NEXT HEAVY

abcdefghijklmnopqrstuvxyz
ABCDEFGHIJKLMNOPQRSTUVWXYZ
0123456789

Aa

AVENIR NEXT BOLD

abcdefghijklmnopqrstuvxyz
ABCDEFGHIJKLMNOPQRSTUVWXYZ
0123456789



GOVERNO DE SANTA CATARINA

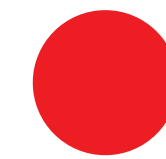

C:00 / M:100 / Y:100 / K:00
R:215 / G: 56 / B: 51
#ED1C24

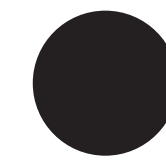

C:69 / M:68 / Y:64 / K:74
R:35 / G: 31 / B: 32
#231F20

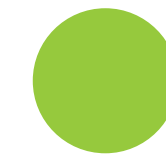

C:47 / M:00 / Y:100 / K:00
R:161 / G: 200 / B: 77
#A1C84D

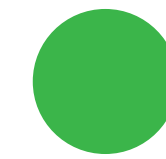

C:75 / M:00 / Y:100 / K:00
R:95 / G: 177 / B: 87
#5FB157

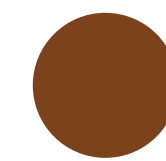

C:35 / M:75 / Y:100 / K:35
R:115 / G: 65 / B: 20
#744214

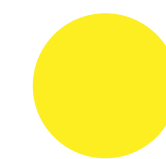

C:05 / M:00 / Y:95 / K:00
R:115 / G: 65 / B: 20
#FCEE21



K: 100

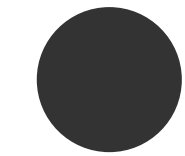

K: 90

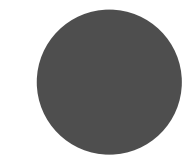

K: 70

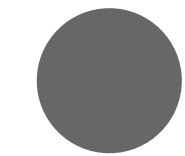

K: 60

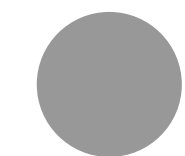

K: 50

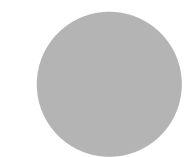

K: 30



K: 10



Área de proteção e Redução máxima



Aplicação em fundos coloridos e complexos



Aplicações Inadequadas



Não alterar **COR**



Não alterar **PROPORÇÃO**



Não alterar **DISPOSIÇÃO**



Não **ACHATAR**



Não **COMPRIMIR**



Não **ALTERAR FONTES**



GOVSC

Padrão de avatar para aplicações digitais





Governo do Estado de Santa Catarina ✓

394 mil seguidores • 155 seguindo

 Seguindo

 Pesquisar





**GOVERNO DE
SANTA
CATARINA**

← Responder

→ Encaminhar

Nome do Secretário | Nome Servidor

Secretaria De Estado da Administração Prisional
Nome / Vice-presidência de Tecnologia
Telefone: +00(00) 0000-0000 / +00(00) 999999-9999



Lorem ipsum dolor sit amet, consectetur a Lorem ipsum dolor sit amet

Lorem ipsum dolor sit amet, consectetur adipiscing elit, sed diam nonummy nibh euismod tincidunt ut laoreet dolore magna aliquam erat volutpat. Ut wisi enim ad minim veniam, quis nostrud exerci tation ullamcorper suscipit lobortis nisl ut aliquip ex ea commodo consequat.

Duis autem vel eum iriure dolor in hendrerit in vulputate velit esse molestie consequat, vel illum dolore eu feugiat nulla facilisis at vero eros et accumsan et iusto odio dignissim qui blandit praesent luptatum zzril delenit augue dui dolore te feugait nulla facilisi.

Lorem ipsum dolor sit amet, consectetur adipiscing elit, sed diam nonummy nibh euismod tincidunt ut laoreet dolore magna aliquam erat volutpat. Ut wisi enim ad minim veni

Padrão sinalização interna: Portas e Banheiros

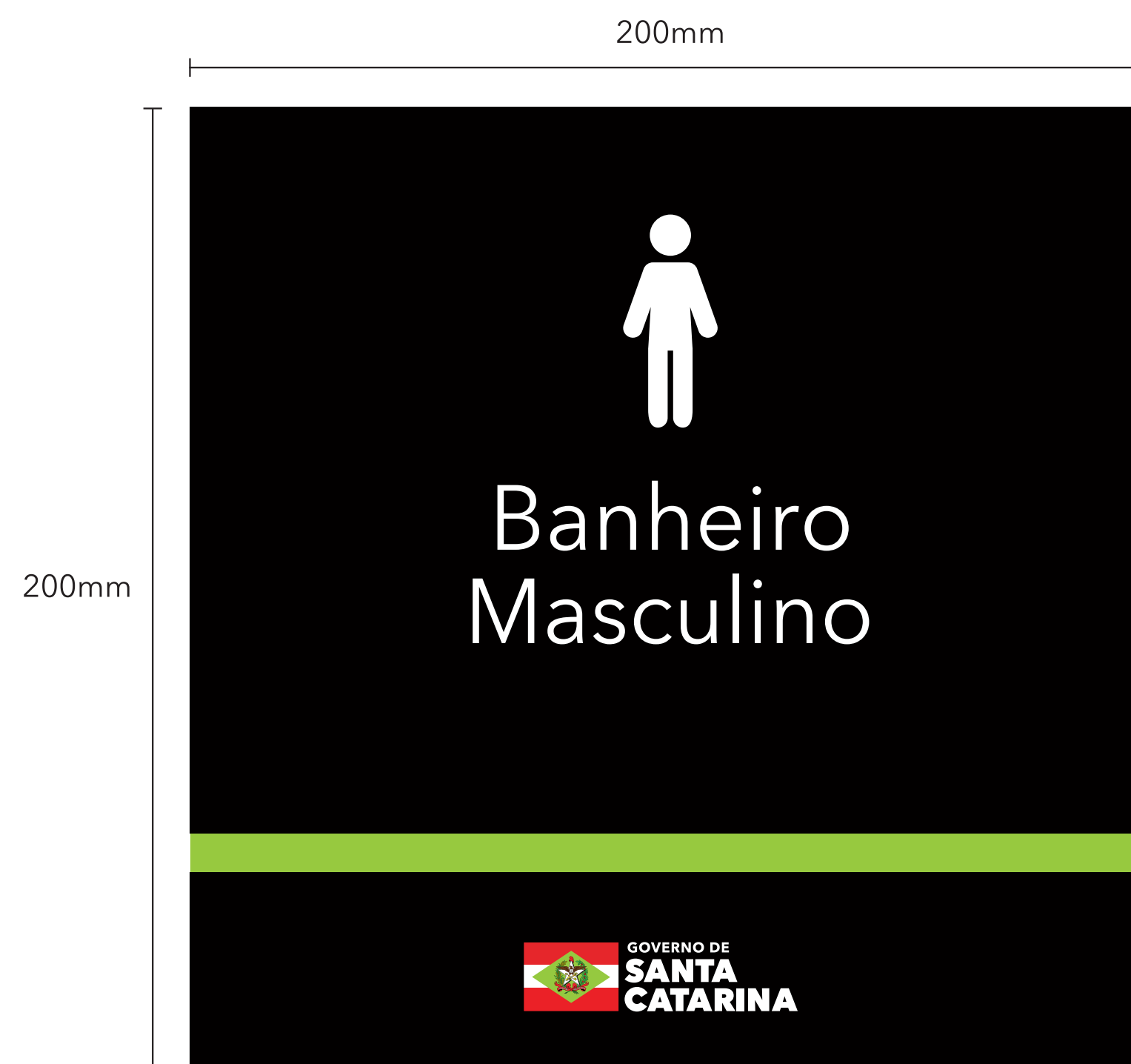

Modelo na proporção 3x1 módulos texto em tipos da família avenir centralizado nos dois módulos da direita no valor de 1/5 de módulo

 GOVERNO DE SANTA CATARINA			<h1>DESCRIÇÃO DA OBRA</h1>				
Convênio Nº 000.000-00			Valor: R\$ 0.000.000,00				
Recurso Estadual: R\$ 0.000.000,00			Contrapartida: R\$ 0.000.000,00				
Concedente: Nome do Concedente			Órgão/Entidade Executora: Nome da Entidade				
Prazo execução: 000 dias		Início: 00/00/0000		Término: 00/00/0000			
Construtora: Nome da Empreiteira			Mais informações: www.sctransferencia.sc.gov.br				

Padrão placas de Identificação (Emenda Impositiva)









De acordo com a determinação do Decreto Nº 1684, de 21 de janeiro de 2022.

NOME DO OBJETO DE EXECUÇÃO - Descrever a obra em questão: ponte, duplicação, asfalto, calçamento, etc.

LOGOMARCA DO MUNICÍPIO - Aplicar a logomarca do município parceiro - de preferência na versão horizontal - dentro da área delimitada.

- Deletar o retângulo de marcação.

NOME DO OBJETO DE EXECUÇÃO		MODALIDADE: CONVÊNIO	
ESSA OBRA CONTA COM RECURSOS DO GOVERNO DO ESTADO.			
Número do Convênio: 0000000000000000		Ano: 0000	
Valor total: R\$ 000.000.000,00		EXECUÇÃO:	
Repasso do Estado: R\$ 000.000,00		APLICAR AQUI A LOGOMARCA DO MUNICÍPIO	
Contrapartida do Município: R\$ 000.000,00		PARTICIPAÇÃO ORÇAMENTÁRIA:	
		 GOVERNO DE SANTA CATARINA	

RGB			PANTONE			CMYK			
	R 33	G 86 B 14		21560E		C - 85	M - 40	Y - 100	K - 40
	R 252	G 106 B 6		FC6A06		C - 0	M - 69	Y - 95	K - 0
	R 56	G 142 B 20		388E14		C - 78	M - 18	Y - 100	K - 5

Proporção 3 x 1

Texto em tipos da família Montserrat.

Padrão placas de Identificação (Convênio)

De acordo com a determinação do Decreto Nº 1684, de 21 de janeiro de 2022.

NOME DO OBJETO DE EXECUÇÃO - Descrever a obra em questão: ponte, duplicação, asfalto, calçamento, etc.

LOGOMARCA DO MUNICÍPIO - Aplicar a logomarca do município parceiro - de preferência na versão horizontal - dentro da área delimitada.
- Deletar o retângulo de marcação.

NOME DO OBJETO DE EXECUÇÃO		MODALIDADE: EMENDA IMPOSITIVA	
ESSA OBRA CONTA COM RECURSOS DO GOVERNO DO ESTADO.			
Número da Emenda: 000000000000 Ano: 0000		Nº da Lei Orçamentária Anual: 000000000000	
Valor total: R\$ 000.000.000,00		EXECUÇÃO:	PARTICIPAÇÃO ORÇAMENTÁRIA:
Repasse do Estado: R\$ 000.000,00		APLICAR AQUI A LOGOMARCA DO MUNICÍPIO	 GOVERNO DE SANTA CATARINA
Contrapartida do Município: R\$ 000.000,00			

RGB			PANTONE			CMYK			
■ R 33	G 86	B 14	■ 21560E			■ C - 85	M - 40	Y - 100	K - 40
■ R 249	G 176	B 15	■ F9B00F			■ C - 0	M - 35	Y - 93	K - 0
■ R 56	G 142	B 20	■ 388E14			■ C - 78	M - 18	Y - 100	K - 5

Proporção 3 x 1

Texto em tipos da família Montserrat.

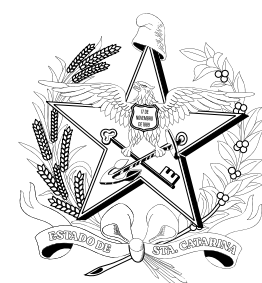

GOVERNO DO ESTADO DE SANTA CATARINA

NOME SOBRENOME
CARGO + SECRETARIA

Rod. SC 401, km 05, nº 4.600 Florianópolis - SC / CEP 88.030-901
(48) XXXXXXXX - nono@nonono.sc.gov.br -  @governosc



GOVERNO DE
**SANTA
CATARINA**
SECRETARIA DA SAÚDE



GOVERNO DE
**SANTA
CATARINA**
SECRETARIA DA ADMINISTRAÇÃO
PRISIONAL E SOCIOEDUCATIVA



SES
SECRETARIA DA SAÚDE



SAP
SECRETARIA DA ADMINISTRAÇÃO
PRISIONAL E SOCIOEDUCATIVA



SES
SECRETARIA DA SAÚDE



SAP
SECRETARIA DA ADMINISTRAÇÃO
PRISIONAL E SOCIOEDUCATIVA



Secretaria da Saúde

Secretaria da Administração
Prisional e Socioeducativa



SES
SAP





GOVERNO DE
SANTA
CATARINA